

Selector ball valve combinations Steel

BK3

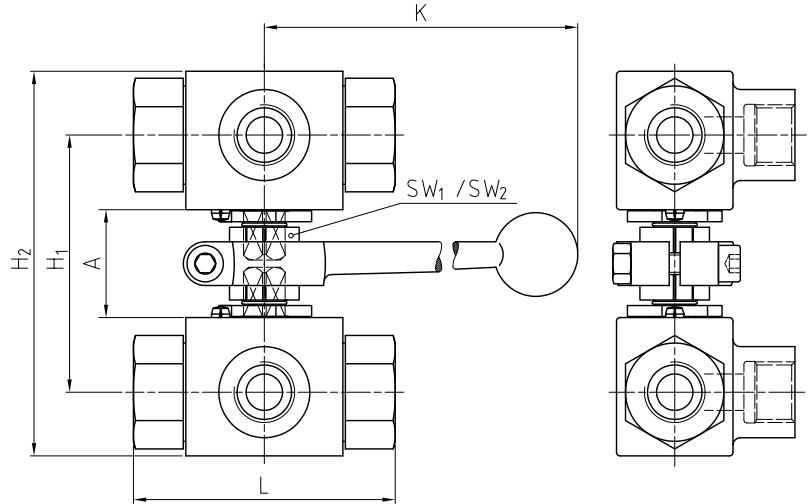
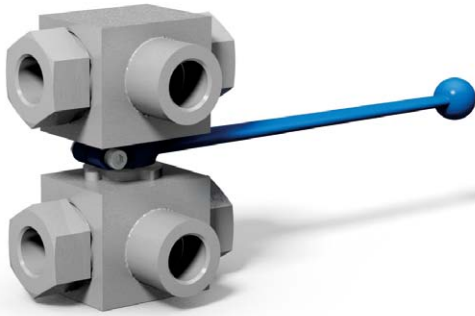

Detailed dimensions:
Catalog page 92 to 95

SW₁: Wrench size of stem
SW₂: Wrench size of lever

**Pressure inlet only
from center port!**

AVAILABLE SIZES

DN4 - DN25 (1/8" to 1")

CONNECTIONS

DIN ISO 228 Female thread, ANSI B1.20.1 NPT Female thread, DIN 2353/ISO 8434-1 Light / Heavy series, SAE J 514/ISO/DIS11926-1 Female thread, others on request

ACCESSORIES ON REQUEST

- Locking devices on request
- Actuators on request
- Mounting holes on request
- Position switches on request

MATERIAL CODE DESCRIPTION

Materials	112A
Body	Steel
Ball	Steel
Stem	Steel
Ball seats	POM
O-rings	NBR
Tmin /Tmax	-20°C / 100°C
Porting pattern	L=SB50

PORTING PATTERNS





Further porting patterns page 262 to 267

GENERAL DIMENSIONS

Type	SW ₁	SW ₂	A	H ₁	H ₂	K	Lever
BK3-DN4	9	14	30	69	96	200	Zn
BK3-DN6	9	14	30	69	96	200	Zn
BK3-DN8	9	14	30	69	96	200	Zn
BK3-DN10	9	14	30	71	106	200	Zn
BK3-DN13	9	14	30	72	110	200	Zn
BK3-DN20	14	17	39	104	153	320	Al
BK3-DN25	14	17	39	110	169	320	Al
BK3-DN25/32	14	17	39	110	169	320	Al

Selector ball valve combinations Steel

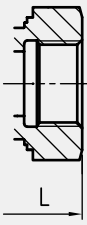
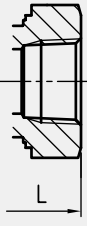
BK3

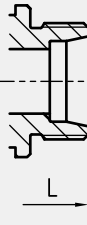
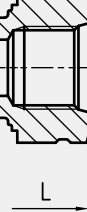
CONNECTION TYPE	DIMENSIONS			ORDER CODE PER MATERIAL COMBINATION	
	Type	L	Weight [Kg]	PN [bar]	112A L=SB50
	BK3-DN4-G1/8	69	0,78	500	38501*
	BK3-DN6-G1/4	69	0,90	500	38502*
	BK3-DN10-G3/8	72	1,25	500	20593*
	BK3-DN13-G1/2	83	1,45	500	38503*
	BK3-DN20-G3/4	95	3,68	315	33719*
	BK3-DN25-G1	113	4,90	315	38504*
	BK3-DN25/32-G1 1/4	120	5,38	315	38505*
	Type	L	Weight [Kg]	PN [bar]	112A L=SB50
	BK3-DN4-1/8"NPT	69	0,78	500	38511*
	BK3-DN6-1/4"NPT	69	0,90	500	38512*
	BK3-DN10-3/8"NPT	72	1,20	500	38513*
	BK3-DN13-1/2"NPT	83	1,40	500	38514*
	BK3-DN20-3/4"NPT	95	3,65	315	38515*
	BK3-DN25-1"NPT	113	4,90	315	38516*
	BK3-DN25/32-1 1/4"NPT	120	5,38	315	38517*
	Type	L	Weight [Kg]	PN [bar]	112A L=SB50
	BK3-DN4-6L	67	0,58	500	38486*
	BK3-DN6-8L	67	0,78	500	38487*
	BK3-DN8-10L	74	0,78	500	23786*
	BK3-DN10-12L	74	0,98	500	38488*
	BK3-DN13-15L	82	1,31	500	38489*
	BK3-DN20-22L	101	3,10	315	38490*
	BK3-DN25-28L	108	4,30	315	38491*
BK3-DN25/32-35L	112	5,20	315	38492*	
	Type	L	Weight [Kg]	PN [bar]	112A L=SB50
	BK3-DN4-8S	73	0,80	500	38493*
	BK3-DN6-10S	73	0,84	500	38494*
	BK3-DN8-12S	76	0,86	500	38495*
	BK3-DN10-14S	80	0,98	500	38496*
	BK3-DN13-16S	86	1,41	500	38497*
	BK3-DN20-25S	109	3,30	315	38498*
	BK3-DN25-30S	120	4,90	315	38499*
BK3-DN25/32-38S	124	5,70	315	38500*	
	Type	L	Weight [Kg]	PN [bar]	112A L=SB50
	BK3-DN6-7/16"UNF	69	0,98	500	38506*
	BK3-DN10-9/16"UNF	72	1,18	500	38507*
	BK3-DN13-3/4"UNF	83	1,41	500	38508*
	BK3-DN20-1 1/16"UN	95	3,70	315	38509*
	BK3-DN25-1 5/16"UN	113	5,50	315	38510*

Please note the pressure ratings of the tube connections!

*Article usually in stock.