

CONTINENTAL



HYDRAULICS

CONTINENTAL HYDRAULICS

# VSD03M\*-S

SOLENOID OPERATED DIRECTIONAL ANTI-SHOCK VALVES



VSD03M\*-S - SOLENOID OPERATED DIRECTIONAL ANTI-SHOCK VALVES

# DURABLE

## VSD03M\*-S SOLENOID OPERATED DIRECTIONAL ANTI-SHOCK VALVES

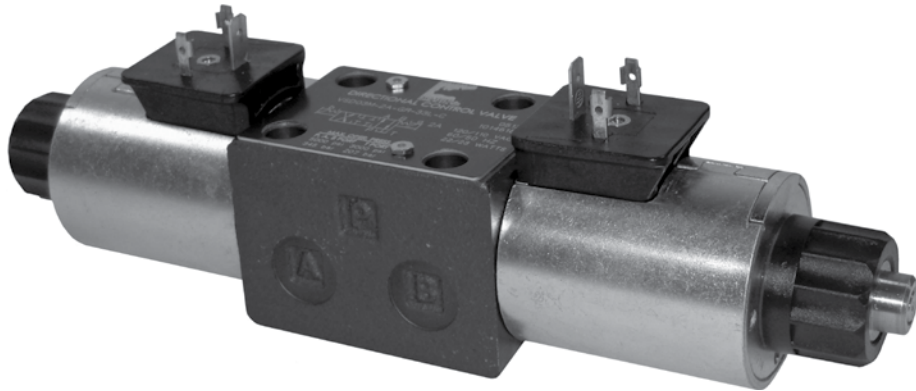

### DESCRIPTION

These valves conform to NFPA D03 and ISO 4401 mounting standards. As the valve spool shifts, the spool lands cross-over the valve body ports. This can produce high instantaneous flow rates.

The anti-shock valve provides a slow spool movement; slower than that of a standard directional valve. This results in reduction or elimination of hydraulic system shock produced by the spool movement and high flow rates.

### TYPICAL PERFORMANCE SPECIFICATIONS

<b>MAXIMUM OPERATING PRESSURE</b>	P - A - B Ports	5000 psi	350 bar
	T Port	3000 psi	210 bar
<b>FLOW RATE</b>		20 gpm	76 l/min
<b>MOUNTING SURFACE</b>		NFPA D03 ISO 4401-03-02-0-03	
<b>MAXIMUM WEIGHT</b>	DC	4.6 lbs	2.1 kg

<b>RANGE TEMPERATURES</b>	Ambient	-4 to +130 °F	-20 to +54 °C
	Fluid	-4 to +180 °F	-20 to +82 °C
<b>FLUID VISCOSITY</b>	Range	60-1900 SUS	10-400 cSt
	Recommended	120 SUS	25 cSt
<b>FLUID CONTAMINATION</b>		ISO 4406:1999 Class 20/18/15	

# IDENTIFICATION CODE

**VSD03M** -  -  -  **S** -  -  -  -  **L** -  \_\_\_\_\_ DESIGN LETTER

SOLENOIDS - See the codes on page 9

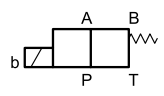
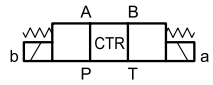
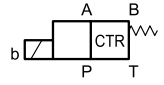
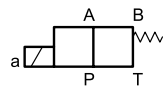
FUNCTION	
<b>1</b>	 <p>Single Solenoid 2 Position Spring Offset</p>
<b>3</b>	 <p>Dual Solenoid 3 Position Spring Centered</p>
<b>5</b>	 <p>Single Solenoid 2 Position Spring Centered</p>
<b>9</b>	 <p>Single Operator 2 Position - 3 Way Spring Offset</p>

SEAL	
<b>A</b>	Buna (STD)
<b>G</b>	Viton

Spool Type  
See Next Page

MECHANICAL OMIT IF NOT REQUIRED	
<b>R</b>	Single Solenoid Operator At 'B' Port End.
<b>WD</b>	Wash-Down

CONNECTION BOX OPTIONS OMIT IF NOT REQUIRED	
See the codes on page 8	

ELECTRICAL OPTION	
<b>OMIT</b>	Plug-in terminal solenoids or lead wires
<b>B</b>	Connection box with terminal posts and lights

TYPICAL ORDERING CODE:  
**VSD03M-3A-AS-B5A-70L-C**  
**VSD03M-3AC-16-AS-44L-C**

VSD03M\*-S - SOLENOID OPERATED DIRECTIONAL ANTI-SHOCK VALVES

SPOOLS					
NAME	SYMBOL	FUNCTION	CENTER POSITION	CROSSOVER	FUNCTION MATCHING
A			All ports blocked	All ports blocked	1
A1			All ports blocked	P→B and A→T restricted or P→A and B→T restricted	3
AC-08			All ports blocked	All ports blocked	3
AC-16			All ports blocked	All ports blocked	3
AC-26			All ports blocked	All ports blocked	3
B1			All ports open	All ports open	1, 3
F1			P blocked, A and B restricted to T	P blocked, A or B restricted to T	3, 5
FC-08			P blocked, A and B restricted to T	All ports blocked	3
FC-16			P blocked, A and B restricted to T	All ports blocked	3
FC-26			P blocked, A and B restricted to T	All ports blocked	3
L1			P→T A and B blocked	All ports open, restricted	3, 5
X			-	All ports blocked	9

These are the standard configurations. Contact Continental Hydraulics for special versions.

# PRESSURE DROPS ΔP-Q

(OBTAINED WITH VISCOSITY OF 170 SUS - 36 CST AT 70°F - 50°C)

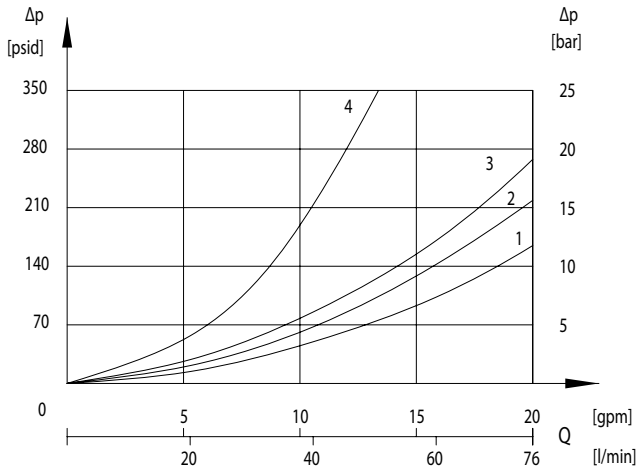

SPOOL	FLOW CURVE NUMBER				
	SHIFTED				CENTER
	P→A	P→B	A→T	B→T	P→T
A, A1	2	2	3	3	
B	1	1	3	3	2
L	4	4	4	4	3
9X	3	3			

# PERFORMANCE CURVE

DC VOLTAGE

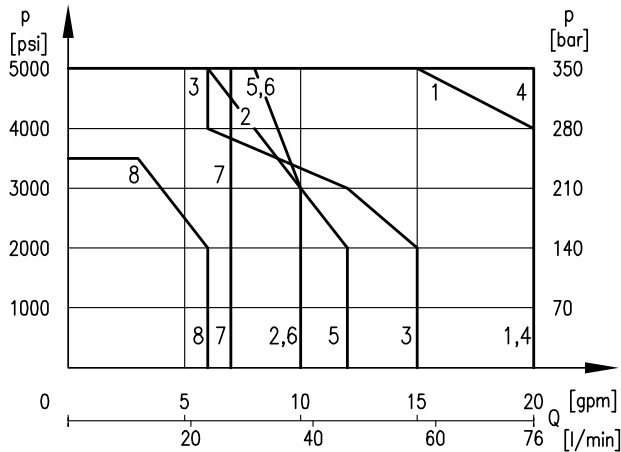

CURVE	SPOOL
1	A1
2	L1
3	B1, 9X
4	F1
5	3AC-26, 3FC-26
6	3AC-16, 3FC-16
7	3AC-08, 3FC-08
8	1A, 1B1

VSD03M\*-S - SOLENOID OPERATED DIRECTIONAL ANTI-SHOCK VALVES

# OVERALL AND MOUNTING DIMENSIONS - CONNECTION BOX VERSION

VSD03M, 3\*

Dimensions in mm [IN]

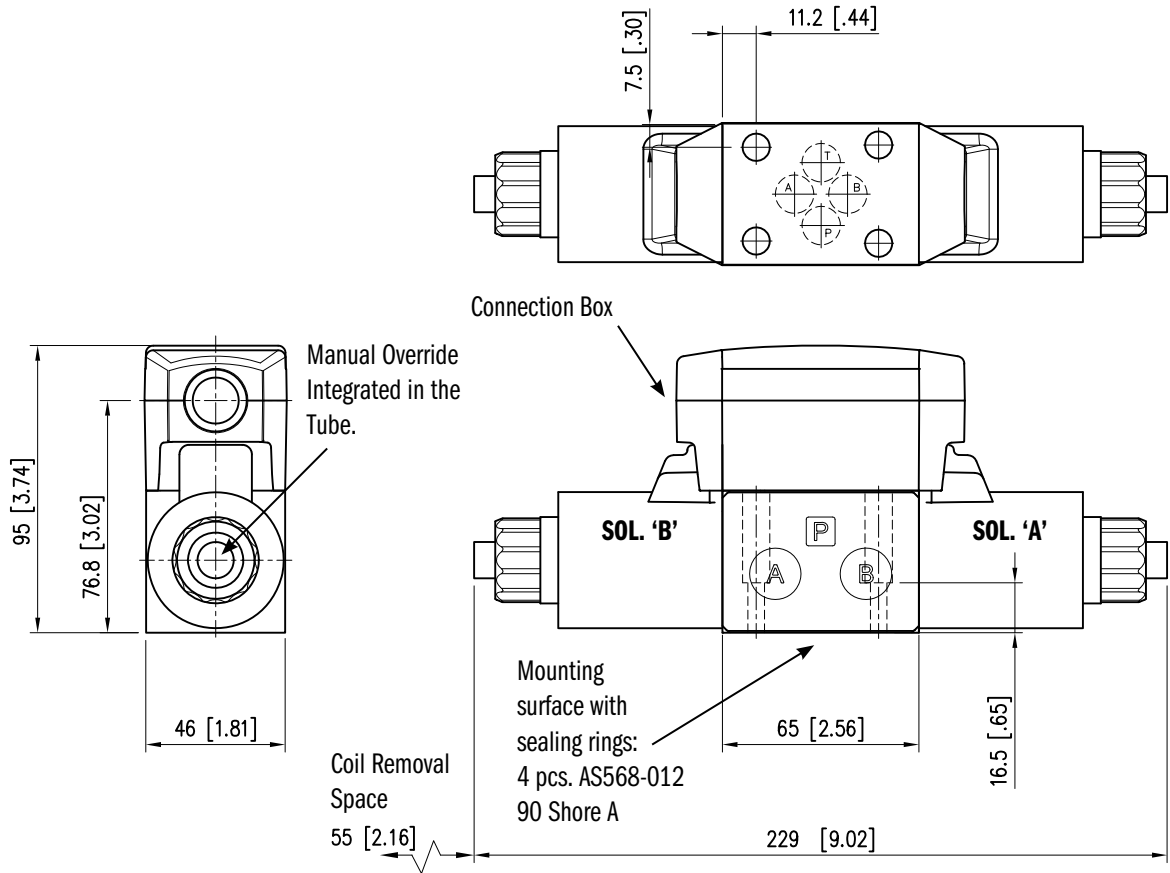

VSD03M-1\*, 5\*, 9\*

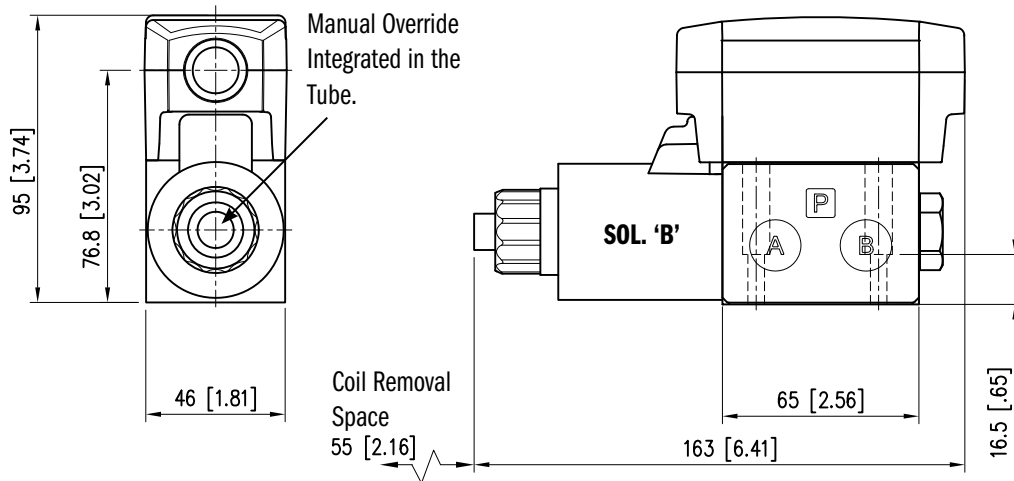

# OVERALL AND MOUNTING DIMENSIONS - DIN STYLE VERSION

VSD03M, 3\*

Dimensions in mm [IN]

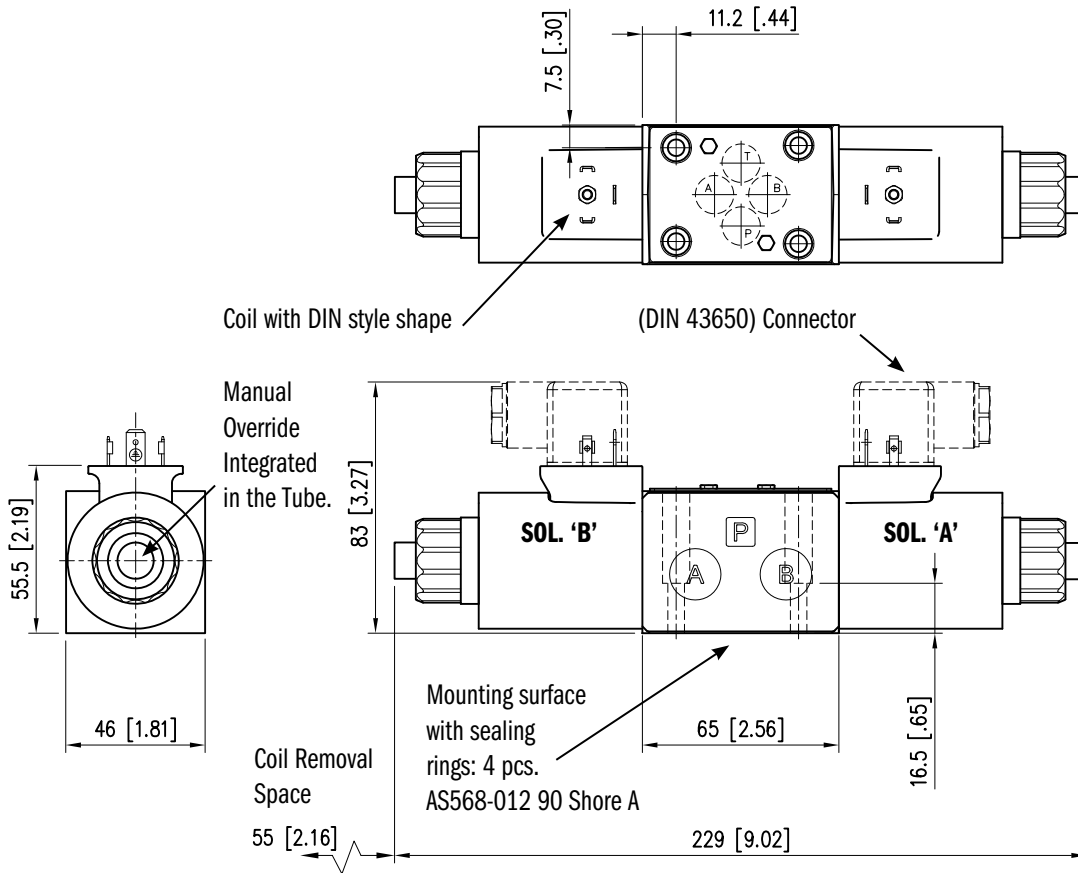

VSD03M-1\*, 5\*, 9\*

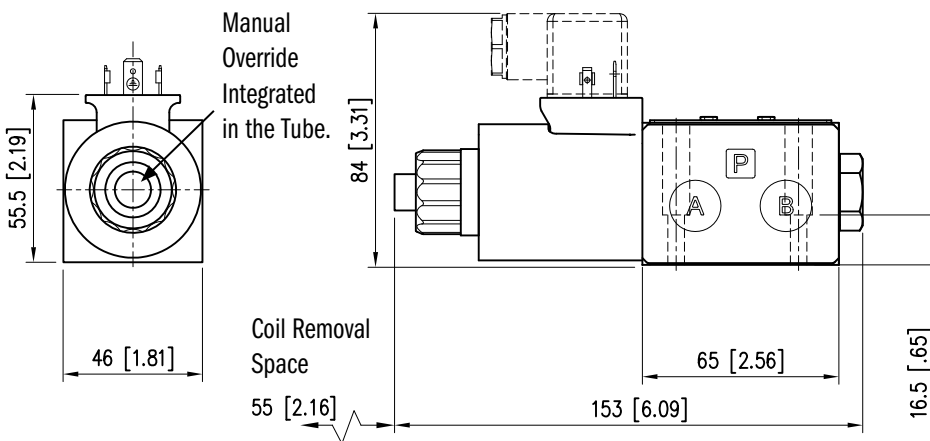

# ELECTRICAL CHARACTERISTICS

Valves are available with an electrical connection box or with DIN 43650 solenoids, Deutsch DT04 or lead wires are also available.

## CONNECTION BOX OPTIONS

To simplify the connections and prevent wiring mistakes, we offer the option of connection boxes with quick connect pin receptacles, already wired.

Valves are available with receptacles on solenoid side 'A' or 'B' and several connector styles.

Below are the codes to be included in the box 'option' of the ordering code, depending on the version you choose.

Wiring diagrams below shows the standard connections for 3-pin, 4-pin and 5-pin connectors. The commercially available mating "female" connector are not included.

CODE	PIN	SHAPE	PORT END	NOTES
5A	5	Male Mini	A	Single and Dual Solenoid
5H	5		B	
3A	3	Male Mini	A	Single Solenoid Only
3H	3		B	
4A	4	Male Micro	A	Different Wiring. See Schematics.
D4A	4		A	
4	4		B	
D4	4		B	

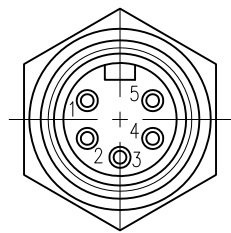

**5 PIN RECEPTACLE**  
Male mini receptacles conform to NFPA/T3.5.29 R1 - 2007 used with single or double solenoid valve.  
26 mm [1"] Wrench

1	Lead to Solenoid B
2	Lead to Solenoid A
3	Ground Lead (Green)
4	Lead to Solenoid A
5	Lead to Solenoid B

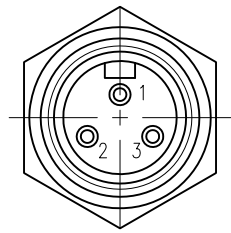

**3 PIN RECEPTACLE**  
Male mini receptacles conform to NFPA/T3.5.29 R1 - 2007 used with single solenoid valve.  
26 mm [1"] Wrench

1	Ground Lead (Green)
2	Lead to Solenoid
3	Lead to Solenoid

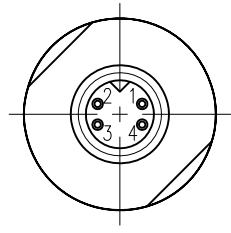

**4 PIN RECEPTACLE**  
Male micro receptacles (M12x1 thread) used with DC valve only.  
23 mm [7/8] Wrench

4A & 4		
1	Brown	Lead to Solenoid A
2	White	No Connection
3	Blue	Common Lead to Sol. A & B
4	Black	Lead to Solenoid B

D4A & D4		
1	Brown	No Connection
2	White	Lead to Solenoid A
3	Blue	Common Lead to Sol. A & B
4	Black	Lead to Solenoid B



# SOLENOIDS

Listed below are the types of solenoids available and the numbers to be added in the solenoid box on page 3.

## PLUG-IN TERMINAL SOLENOID

### DIN 43650

This solenoid has three terminal posts. Use bi-polar connectors that meet ISO 4400 / DIN 43650 (EN 175301-803). Protection against atmospheric agent: IP 65

### LEAD WIRES

6 inch length, protection against atmospheric agent: IP 67

### DEUTSCH DT04 MALE

Protection against atmospheric agent: IP 69  
Connectors must be ordered separately.

### DEUTSCH DT04 MALE

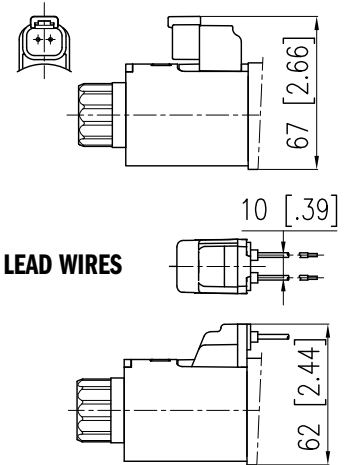

## CONNECTION BOX SOLENOIDS

This is a two-pin solenoid which connects to the circuit board. Wiring is done on the terminal strip inside the box.

DIN CONNECTION CODE	LEAD WIRE CONNECTION CODE	DEUTSCH DT04 CONNECTION CODE	BOX CONNECTION CODE	VOLTAGE & FREQ. [VOLT - HERTZ]	VOLTAGE LIMITS [MIN - MAX]	RESISTANCE ±10% [OHM]	INRUSH CURRENT [A]	HOLDING CURRENT [A]	HOLDING POWER [W]
42	24K4	24K7	70	24 V DC	21 - 26	19.2	1.25	1.25	30
44	12K4	12K7	75	12 V DC	10 - 13	4.8	2.5	2.5	30

## WASHDOWN OPTION (CODE WD)

The wash-down option with the electrical box is designed for an IP65 rating. This option uses a special cover without the mounting bolt access holes and uses silicone sealant to help seal between the coil and core tube.

The DIN, Deutsch and lead wire coils versions of the wash-down option uses silicone sealant to help seal between the coil and core tube.

# APPLICATION DATA

## FLUIDS

All pressure drops shown on these data pages are based on 170 SUS fluid viscosity and 0.87 specific gravity. For any other specific gravity (G1) the pressure drop ( $\Delta P$ ) will be approx.  $\Delta P1 = \Delta P (G1/G)$ . See the chart for other viscosities.

<b>FLUID VISCOSITIES</b>	Cst	10	14.5	32	36	43	54	65	76	86	108	216	324	400
	SUS	60	75	150	170	200	250	300	350	400	500	1000	1500	1900
<b>MULTIPLIER</b>		0.77	0.81	0.97	1.00	1.04	1.10	1.15	1.20	1.24	1.31	1.56	1.72	1.83

Use mineral oil-based hydraulic fluids HL or HM type, according to ISO 6743-4. For these fluids, use NBR seals. For fluids HFDR type (phosphate esters) use FPM seals (code G). For the use of other kinds of fluid such as HFA, HFB, HFC, please consult our technical department.

Using fluids at temperatures higher than 180 degrees F causes the accelerated degradation of seals as well as degradation of the fluids physical and chemical properties.

From a safety standpoint, temperatures above 130 degrees F are not recommended.

<b>RANGE TEMPERATURES:</b>	Ambient	- 4 to +130 °F	-20 to +54 °C
	Fluid	- 4 to +180 °F	-20 to +82 °C
<b>FLUID VISCOSITY</b>	Range	60 -1900 SUS	10 - 400 cSt
	Recommended	120 SUS	25 cSt
<b>FLUID CONTAMINATION</b>	ISO 4406:1999 Class 20/18/15		

## INSTALLATION

Valves with centering and return springs can be mounted in any position without impairing correct operation. Valves with mechanical detent should have horizontal mounting.

Valves are fixed by means of screws or tie rods on a flat surface with planarity and roughness equal to or better than those indicated in the relative symbols. If minimum values are not observed, fluid can easily leak between the valve and support surface.

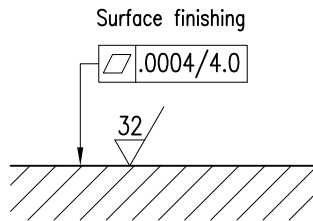

## SEAL KIT

Buna Seal Kit	1013326
Viton Seal Kit	1013327

## BOLT KIT

VSD03M	121472
--------	--------



POWERFUL  
ACCURATE  
INNOVATIVE  
PRECISE  
DURABLE  
EFFICIENT  
VERSATILE

## ABOUT CONTINENTAL HYDRAULICS

Rugged, durable, high-performance, efficient—the reason Continental Hydraulics' products are used in some of the most challenging applications across the globe. With a commitment to quality customer support and innovative engineering, Continental's pumps, valves, power units, mobile and custom products deliver what the markets demand. Continental has been serving the food production, brick and block, wood products, automotive and machine tool industries since 1962. Learn how our products survive some of the most harsh environments.

**SALES@CONTHYD.COM**

4895 12th Avenue East, Shakopee, MN 55379 / [continentalhydraulics.com](http://continentalhydraulics.com) / 952-895-6400

CONTINENTAL



HYDRAULICS