

Solenoid Operated Directional Valves, DSG-005 Series

These DSG-005 series solenoid directional valves are the products newly developed as a “Mini-series”. Compared with DSG-01 series, the valve are much more compactly manufactured but enjoy a maximum operating pressure of 25 MPa (3630 PSI) and a maximum flow rate of 15 L/min (3.96 U.S.GPM), while contributing further to a space saving requirement. Moreover, using wet armature solenoids, the valves ensure the long life.

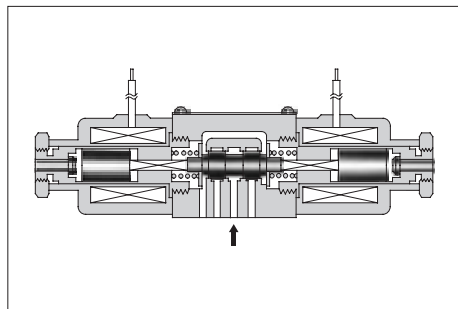

Specifications

Model Numbers	Max. Flow★ L/min (U.S.GPM)	Max. Operating Pressure MPa (PSI)	Max. Tank-Line Back Pressure MPa (PSI)	Max. Changeover Frequency min ⁻¹ (Cycles/min)	Approx. Mass kg (lbs.)
DSG-005-3C*- *-40/4090	15 (3.96)	25 (3630)	7 (1020)	120	0.5 (1.1)
DSG-005-2B*- *-40/4090					0.4 (.9)

★ The maximum flow means the limited flow without inducing any abnormality to the operation (changeover) of the valve. The maximum flow differs according to the type and operating conditions. For details, please refer to the “List of Standard Models and Maximum Flow” on pages 338 to 339.

Solenoid Rating

Electric Source	Coil Type	Frequency (Hz)	Voltage (V)		Current & Power at Rated Voltage		
			Source Rating	Serviceable	Inrush★ ¹ (A)	Holding (A)	Power (W)
AC	A100	50	100	80 – 110	0.36	0.16	—
		60		90 – 120	0.34	0.11	
	A200	50	200	160 – 220	0.18	0.08	
		60		180 – 240	0.17	0.05	
DC★ ²	D12	—	12	10.8 – 13.2	—	1.2	15
	D24	—	24	21.6 – 26.4		0.6	

- ★¹ Inrush current in the above table shows rms values at maximum stroke.
- ★² The Plug-in Connector Type DC solenoid has a built-in surge absorber. The Flying Lead Wire Type has no surge absorber equipped. Install a surge absorber separately.

Model Number Designation

F-	DSG	-005	-3	C	2	-D24	-N	-40	*
Special Seals	Series Number	Valve Size	Number of Valve Position	Spool-Spring Arrangement	Spool Type	Coil Type	Electrical Conduit Connection	Design Number	Design Standard
F: Special Seals for Phosphate Ester Type Fluids (Omit if not required)	DSG: Solenoid Operated Directional Valve	005	3	C: Spring Centred	2, 3 40	AC A100, A200 DC D12, D24	None: Flying Lead Wire Type N: Plug-in Connector Type N1: Plug-in Connector with Indicator Light	40	Refer to [★]
			2	B: Spring Offset	2, 3				

★ Design Standards: None Japanese Standard "JIS" and European Design Standard 90 N. American Design Standard

Sub-plates

Piping Size	Japanese Standard "JIS"		European Design Standard		N. American Design Standard		Approx. Mass kg (lbs.)
	Sub-plate Model Numbers	Thread Size	Sub-plate Model Numbers	Thread Size	Sub-plate Model Numbers	Thread Size	
1/8	DSGM-005X-20	Rc 1/8	DSGM-005X-2080	1/8 BSP.F	DSGM-005X-2090	1/8 NPT	0.8 (1.8)
1/4	DSGM-005Y-20	Rc 1/4	DSGM-005Y-2080	1/4 BSP.F	DSGM-005Y-2090	1/4 NPT	0.8 (1.8)

● Sub-plates are available. Specify the sub-plate model number from the table above. When sub-plates are not used, the mounting surface should have a good machined finish.

Mounting Bolts

Four socket head cap screws in the table below are included.

Descriptions	Soc. Hd. Cap Screw (4 Pcs.)	Tightening Torque
Japanese Standard "JIS" European Design Standard	M4 × 35 Lg.	2.5 - 3.5 Nm (22.1 - 31.0 in. lbs.)
N. American Design Standard	No. 8-32 UNC × 1-3/8 Lg.	

Typical Changeover Time (Example)

Changeover time varies according to oil viscosity, spool type and hydraulic circuit.

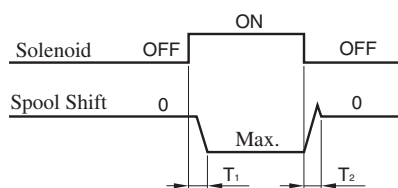

[Test Conditions]

Pressure: 16 MPa (2320 PSI)

Flow Rate: 7.5 L/min (1.98 U.S.GPM)

Viscosity: 30 mm²/s (141 SSU)

Voltage: Rated Voltage (After coil temperature rises and saturated)



Direction of Flow: P → A → B → T
P → B → A → T

[Result of Measurement]

Model Numbers	Time ms	
	T ₁	T ₂
DSG-005-3C2-A*	16	60
DSG-005-3C2-D*	23	40
DSG-005-2B2-A*	14	45
DSG-005-2B2-D*	15	33

■ List of Standard Models and The Maximum Flow

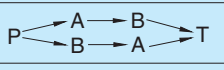
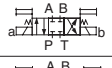

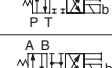
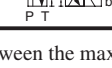
● Models with AC Solenoids : DSG-005-*** -A* -40/4090

No. of Valve Position	Spool-Spring Arrangement	Model Numbers	Graphic Symbols	Max. Flow L/min											
								P → A [Port "B" Blocked]				P → B [Port "A" Blocked]			
				Working Pressure MPa				Working Pressure MPa				Working Pressure MPa			
				5	10	16	25	5	10	16	25	5	10	16	25
Three Positions	Spring Centred	DSG-005-3C2		15	15	15	15	15(14)	15(7)	12(3)	4(0.5)	15(14)	15(7)	12(3)	4(0.5)
		DSG-005-3C3		12	12	12	12	15	15	15	15	15	15	15	15
		DSG-005-3C40		15	15	15	15	15(14)	15(6)	12(2)	4(0.5)	15(14)	15(6)	12(2)	4(0.5)
Two Positions	Spring Offset	DSG-005-2B2		14	14	14	14	2	1	1	1	15(14)	15(10)	13(5)	6(0.5)
		DSG-005-2B3		13.5	13.5	13.5	13.5	3	3	3	3	15	15(14)	15(11)	15(9)

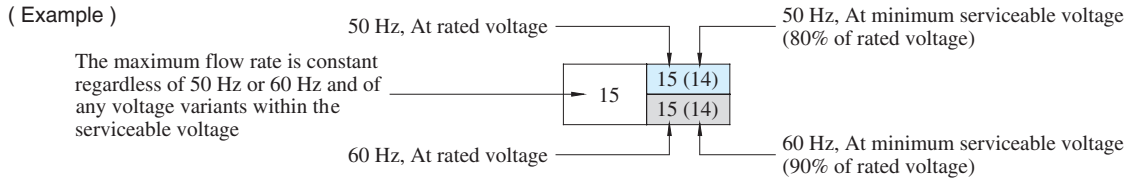
Notes: 1. The relation between the maximum flow in the table above and the frequency/voltage (within the serviceable voltage) is as shown below.

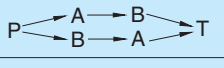
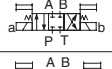

● Models with DC Solenoids : DSG-005-*** -D* -40/4090

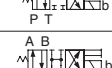
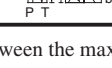
No. of Valve Position	Spool-Spring Arrangement	Model Numbers	Graphic Symbols	Max. Flow L/min											
								P → A [Port "B" Blocked]				P → B [Port "A" Blocked]			
				Working Pressure MPa				Working Pressure MPa				Working Pressure MPa			
				5	10	16	25	5	10	16	25	5	10	16	25
Three Positions	Spring Centred	DSG-005-3C2		15	15	15	15	15	8	5	3	15	8	5	3
		DSG-005-3C3		15	15	15	15	15	15	15	15	15	15	15	15
		DSG-005-3C40		15	15	15	15	15	13	8	5	15	13	8	5
Two Positions	Spring Offset	DSG-005-2B2		14	14	14	14	8.5	4.5	6.5	6.5	15	15	11	9
		DSG-005-2B3		13.5	13.5	13.5	13.5	8	7	8	9	15	15	15	13.5

Notes: 1. The relation between the maximum flow in the table above and the voltage (within the serviceable voltage) is as shown below.

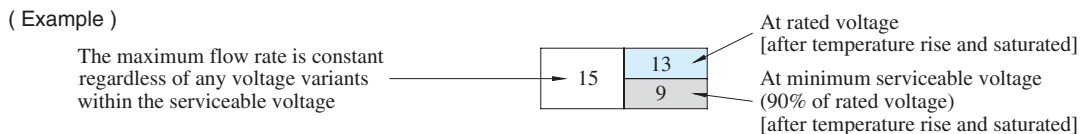

■ List of Standard Models and The Maximum Flow

● Models with AC Solenoids : DSG-005-***-A*-40/4090

No. of Valve Position	Spool-Spring Arrangement	Model Numbers	Graphic Symbols	Max. Flow U.S.GPM											
				Working Pressure PSI				Working Pressure PSI				Working Pressure PSI			
				730	1450	2320	3630	730	1450	2320	3630	730	1450	2320	3630
Three Positions	Spring Centred	DSG-005-3C2		4.0	4.0	4.0	4.0	4.0(3.7)	4.0(1.9)	3.2(.8)	1.1(.1)	4.0(3.7)	4.0(1.9)	3.2(.8)	1.1(.1)
		DSG-005-3C3		3.2	3.2	3.2	3.2	4.0	4.0	4.0	4.0	4.0	4.0	4.0	4.0
		DSG-005-3C40		4.0	4.0	4.0	4.0	4.0(3.7)	4.0(1.6)	3.2(.5)	1.1(.1)	4.0(3.7)	4.0(1.6)	3.2(.5)	1.1(.1)
Two Positions	Spring Offset	DSG-005-2B2		3.7	3.7	3.7	3.7	.5	.3	.3	.3	4.0(3.7)	4.0(2.6)	3.4(1.3)	1.6(.1)
		DSG-005-2B3		3.6	3.6	3.6	3.6	.8	.8	.8	.8	4.0	4.0(3.7)	4.0(2.9)	4.0(2.4)

Notes: 1. The relation between the maximum flow in the table above and the frequency/voltage (within the serviceable voltage) is as shown below.

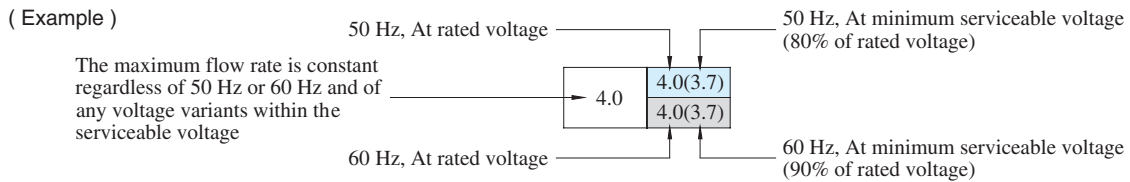

● Models with DC Solenoids : DSG-005-***-D*-40/4090

No. of Valve Position	Spool-Spring Arrangement	Model Numbers	Graphic Symbols	Max. Flow U.S.GPM											
				Working Pressure PSI				Working Pressure PSI				Working Pressure PSI			
				730	1450	2320	3630	730	1450	2320	3630	730	1450	2320	3630
Three Positions	Spring Centred	DSG-005-3C2		4.0	4.0	4.0	4.0	4.0	2.1	1.3	.8	4.0	2.1	1.3	.8
		DSG-005-3C3		4.0	4.0	4.0	4.0	4.0	4.0	4.0	4.0	4.0	4.0	4.0	4.0
		DSG-005-3C40		4.0	4.0	4.0	4.0	4.0	3.4	2.1	1.3	4.0	3.4	2.1	1.3
Two Positions	Spring Offset	DSG-005-2B2		3.7	3.7	3.7	3.7	2.3	1.2	1.7	1.7	4.0	4.0	2.9	2.4
		DSG-005-2B3		3.6	3.6	3.6	3.6	2.1	1.9	2.1	2.4	4.0	4.0	4.0	3.6

Notes: 1. The relation between the maximum flow in the table above and the voltage (within the serviceable voltage) is as shown below.

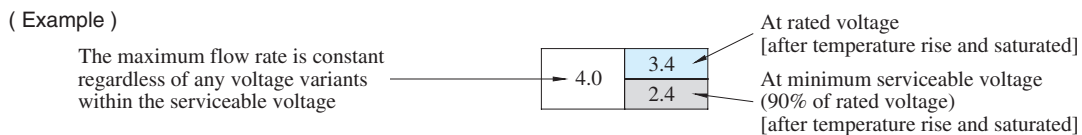

Pressure Drop

Pressure drop curves based on viscosity of 30 mm²/s (141 SSU) and specific gravity of 0.850.

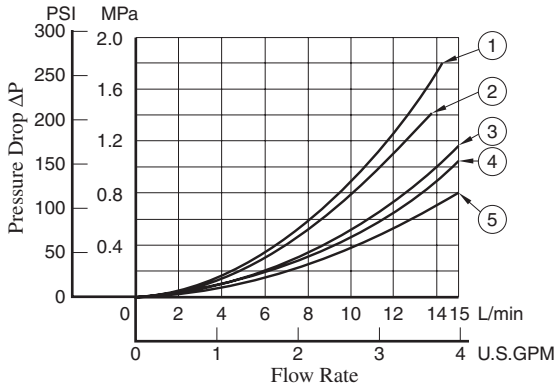

Model Numbers	Pressure Drop Curve Numbers				
	P → A	B → T	P → B	A → T	P → T
DSG-005-3C2	④	④	④	④	—
DSG-005-3C3	⑤	⑤	⑤	⑤	③
DSG-005-3C40	④	④	④	④	—
DSG-005-2B2	①	①	④	④	—
DSG-005-2B3	②	②	④	④	—

● For any other viscosity, multiply the factors in the table below.

Viscosity	mm ² /s	15	20	30	40	50	60	70	80	90	100
	SSU	77	98	141	186	232	278	324	371	417	464
Factor		0.84	0.91	1.00	1.07	1.14	1.19	1.24	1.28	1.32	1.35

● For any other specific gravity (G'), the pressure drop (ΔP) may be obtained from the formula below.

$$\Delta P' = \Delta P (G'/0.850)$$

Flying Lead Wire Type

● Spring Centred: DSG-005-3C* - $\frac{A^*}{D^*}$ -40/4090

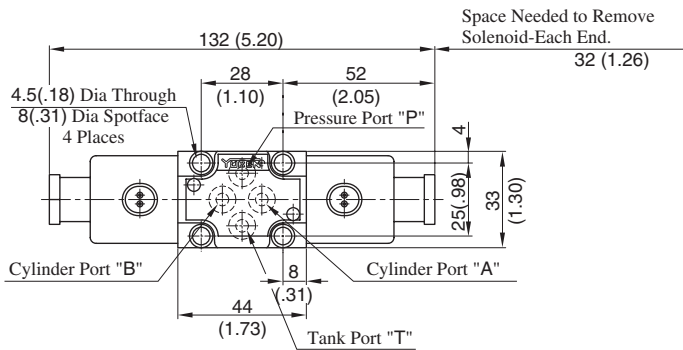

● Spring Offset:
DSG-005-2B* - $\frac{A^*}{D^*}$ -40/4090

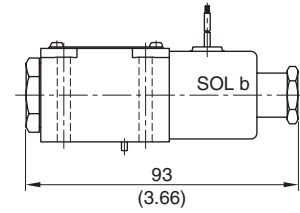

● For other dimensions, refer to "Spring Centred" type.

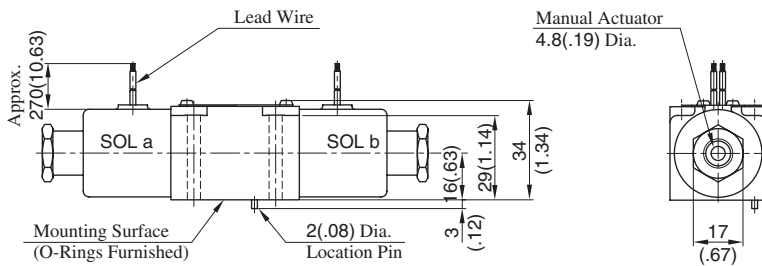

DIMENSIONS IN
MILLIMETRES (INCHES)

DIN Connector Type / DIN Connector with Indicator Light

● Spring Centred: DSG-005-3C* - $\frac{A^*}{D^*}$ -N/N1-40/4090

● Spring Offset: DSG-005-2B* - $\frac{A^*}{D^*}$ -N/N1-40/4090

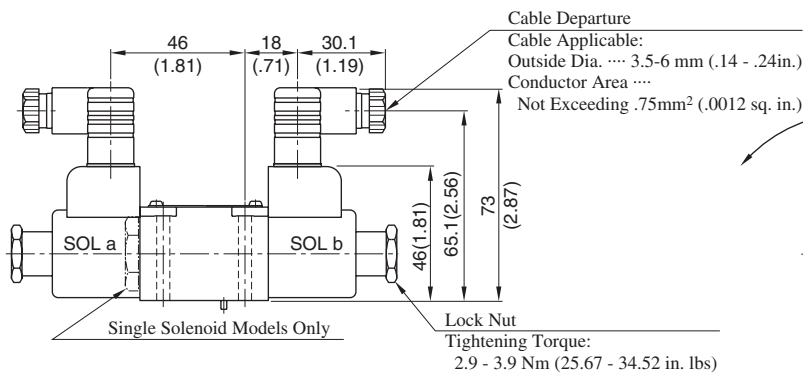

The position of the Plug-in connector can be changed as illustrated below by loosening the lock nut. After completion of the change, be sure to tighten the lock nut with the torque as specified below.

● For other dimensions, refer to "Flying Lead Wire Type".

E

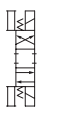

DSG-005 Series Solenoid
Operated Directional Valves

■ Sub-plates: DSGM-005* -20/2080/2090

**DIMENSIONS IN
MILLIMETRES (INCHES)**

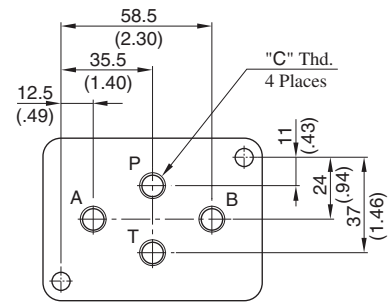
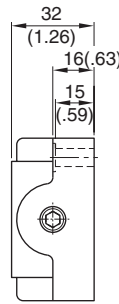
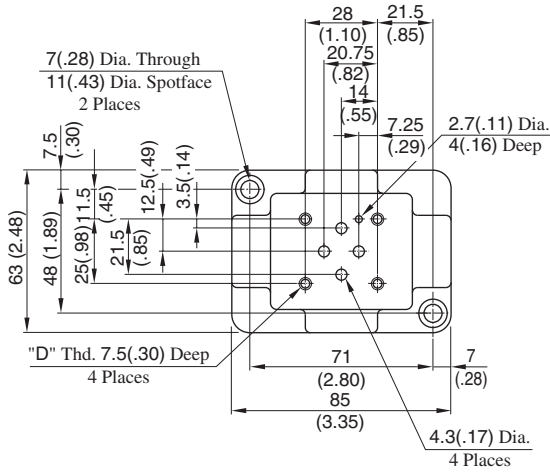

Sub-plate Model Numbers	Piping Size "C" Thd.	"D" Thd.
DSGM-005X-20	Rc 1/8	M4
DSGM-005X-2080	1/8 BSP. F	
DSGM-005X-2090	1/8 NPT	No. 8-32 UNC
DSGM-005Y-20	Rc 1/4	M4
DSGM-005Y-2080	1/4 BSP. F	
DSGM-005Y-2090	1/4 NPT	No. 8-32 UNC

■ List of Seals, Solenoid Ass'y, Coil and Connector Ass'y

DSG-005-***-*-40/4090

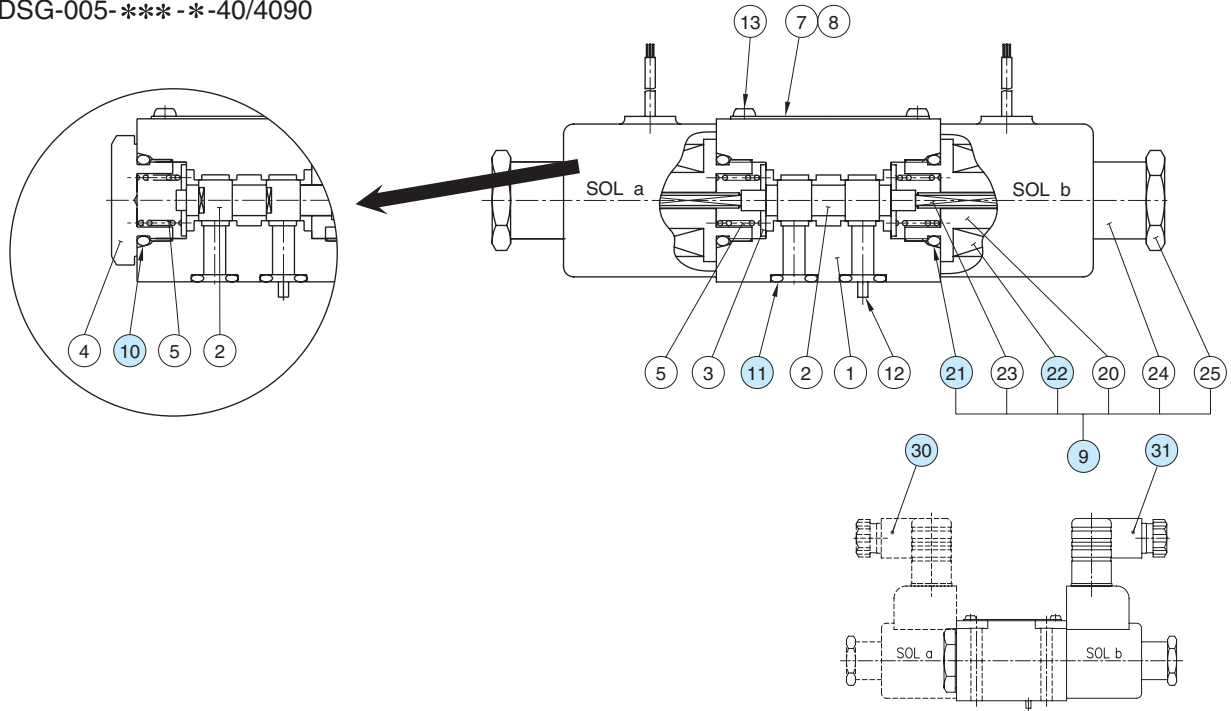

● List of Seals

Item	Name of Parts	Part Numbers	Qty.		Remarks
			3C*	2B*	
10	O-Ring	SO-NB-P14	—	1	
11	O-Ring	SO-NB-P6	4	4	
21	O-Ring	SO-NB-P14	2	1	Included in Solenoid Ass'y

Note: When ordering seals, please specify the seal kit number "KS-DSG-005-40".

■ Solenoid Ass'y, Coil and Connector Ass'y No.

Valve Model Number	⑨ Solenoid Ass'y No.	⑫ Coil No.	⑬ Connector Ass'y Part No.	⑭ Connector Ass'y Part No.	Remarks
DSG-005-***-A100	SA05-100-40	C-SA05-100-40	—	—	Flying Lead Wire Type
DSG-005-***-A200	SA05-200-40	C-SA05-200-40			
DSG-005-***-D12	SD05-12-40	C-SD05-12-40			
DSG-005-***-D24	SD-05-24-40	C-SD-05-24-40			
DSG-005-***-A100-N	SA05-100-N-40	C-SA05-100-N-40	TK290058-7	TK290058-7	Plug-in Connector Type
DSG-005-***-A200-N	SA05-200-N-40	C-SA05-200-N-40			
DSG-005-***-D12-N	SD05-12-N-40	C-SD05-12-N-40			
DSG-005-***-D24-N	SD-05-24-N-40	C-SD-05-24-N-40			
DSG-005-***-A100-N1	SA05-100-N-40	C-SA05-100-N-40	TK290378-9	TK290378-9	Plug-in Connector with Indicator Light
DSG-005-***-A200-N1	SA05-200-N-40	C-SA05-200-N-40	TK290379-7	TK290379-7	
DSG-005-***-D12-N1	SD05-12-N-40	C-SD05-12-N-40	TK290089-2	TK290089-2	
DSG-005-***-D24-N1	SD-05-24-N-40	C-SD-05-24-N-40	TK290090-0	TK290090-0	